

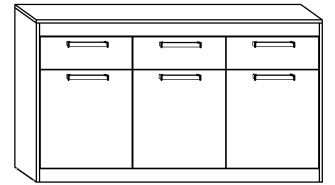













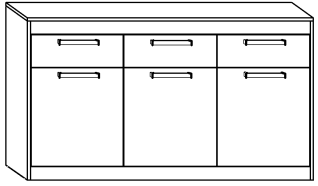



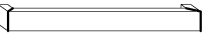





MXS-10 KOMODA 3D3S

→ 148 × 85 × 44



x 8  (a)	x 18  (b)	x 4  (c)	x 22  (d)	x 18  (e)	x 6  (f)		
x 7  (g)	x 1  (h)	x 54 (3,5x16)  (i)	x 12 (3,5x30)  (j)	x 6  (k)	x 95  (l)		x 1  (m)
x 6  (n)	x 2  (o)	x 4  (p)	x 12  (s)	x 2  (t)	x 3 kpl. (350 mm)  (r)		  90 min 



1 - FAZY MONTAŻU

A - OZNACZENIE ELEMENTÓW

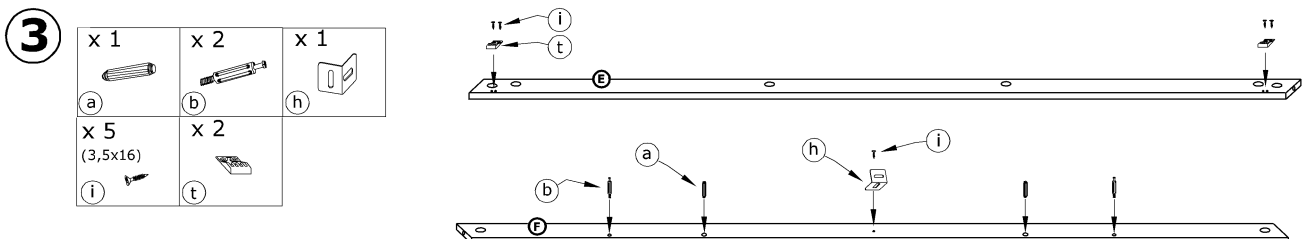
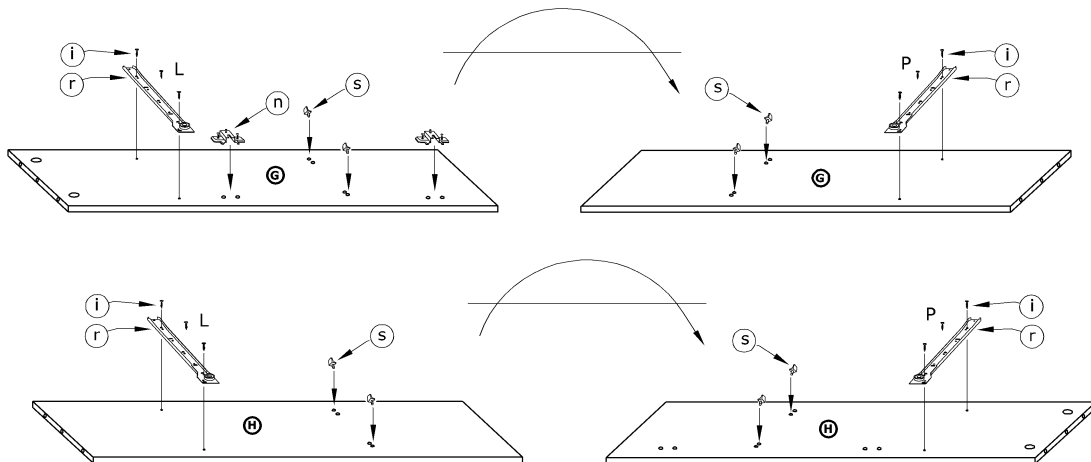
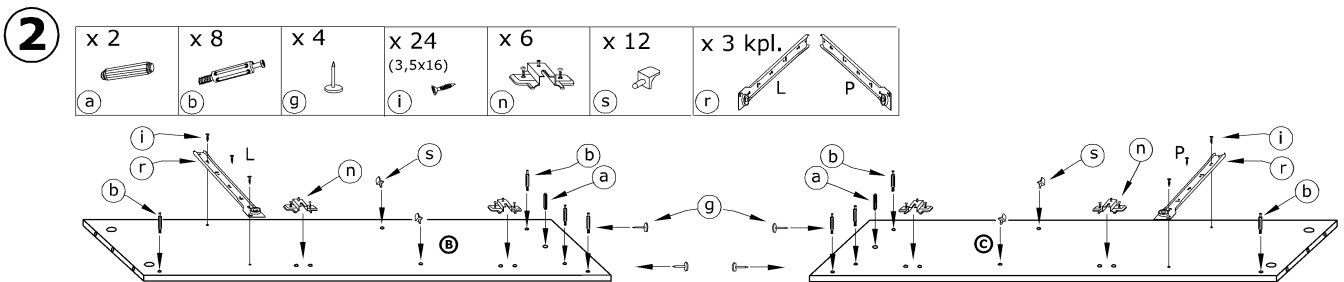
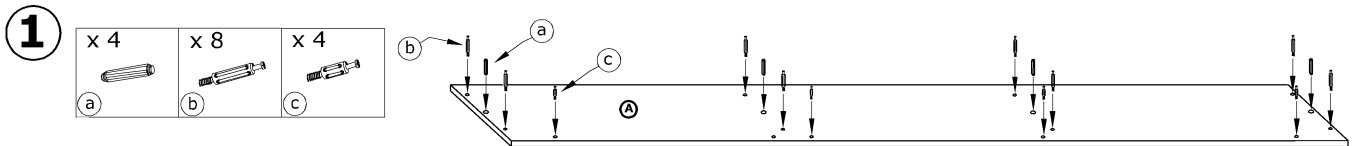
a - OZNACZENIE AKCESORIÓW





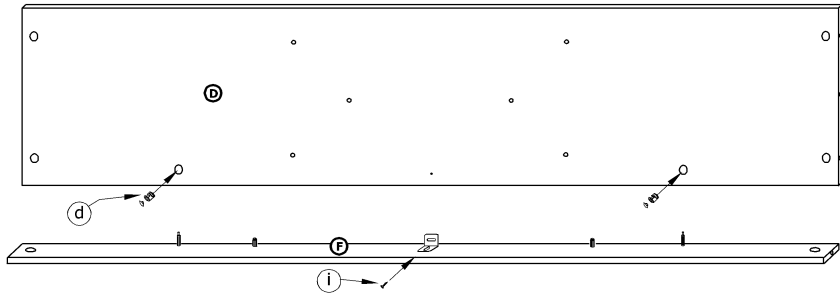

4

- x 2  
- x 1 (3,5x16) 



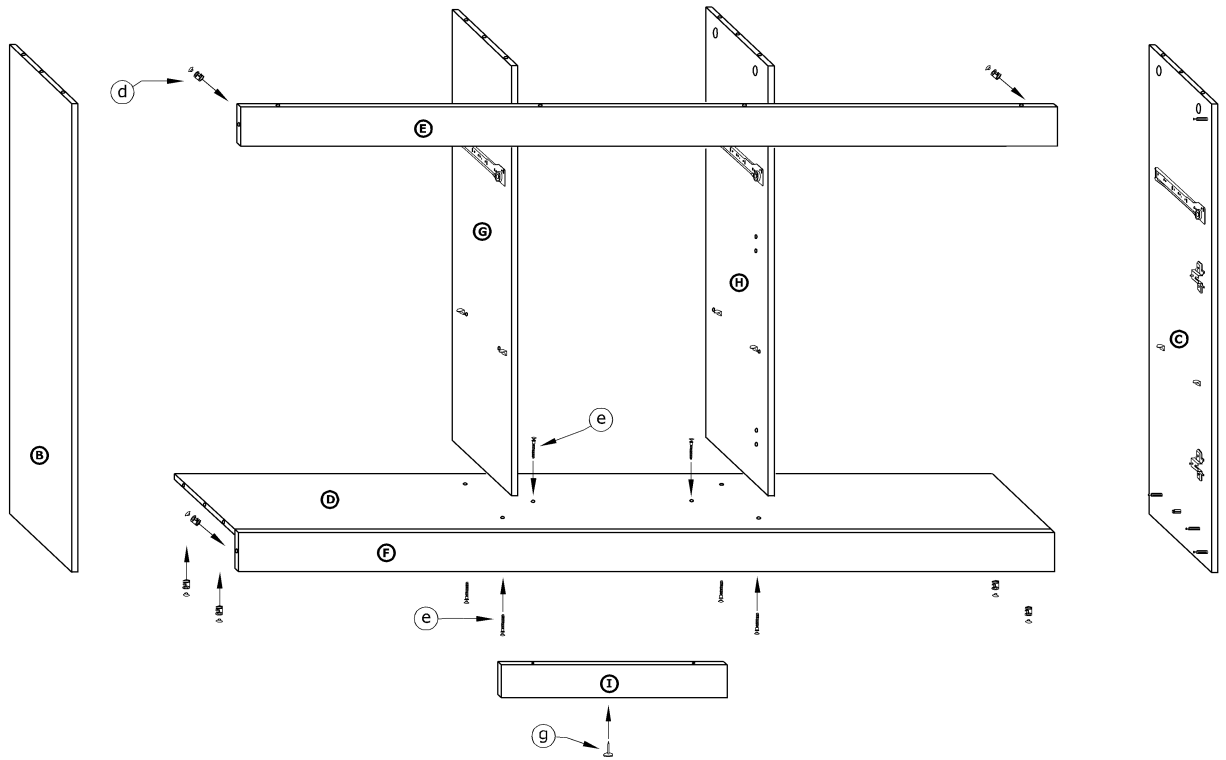

5

- x 8  
- x 6 
- x 1 



6

- x 12  
- x 2 